

SKU: BLMC200C

2" Black Merchant Coupling

Specifications:

- Meets or exceeds ASTM A865 & ASME B1.20.1 standards
- Merchant couplings from 1/8" to 2" are NPSC (straight threads)
- Merchant couplings from 2-1/2" and larger are NPT (tapered.)
- 100% pressure tested before leaving the factory
- Rated at max. 300 psi at 150°F or 150 psi at 300°F

Applications:

Black merchant couplings are threaded steel fittings used to join two pipes of the same size in low-pressure, non-potable systems such as air, gas, and liquid propane. They provide durable, secure connections for moderate temperature and pressure applications, typically 150 psi or less. Common in residential, commercial, and decorative uses, they are not suitable for drinking water systems.

Materials:

- Ungalvanized carbon steel

Certifications/Listings/Approvals:

- ASTM A865
- ANSI/ASME B 1.20.1 / STRAIGHT-TAPPED (NPSC) & TAPERED (NPT)
- ASTM A865
- STANDARD WEIGHT



	OD	Length
NPS	in	in
2"	2.750	2.063

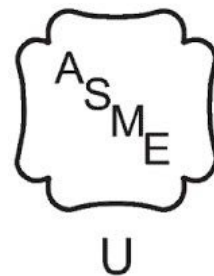

Product Offerings and Dimensions

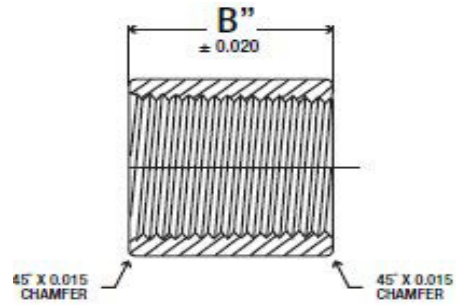
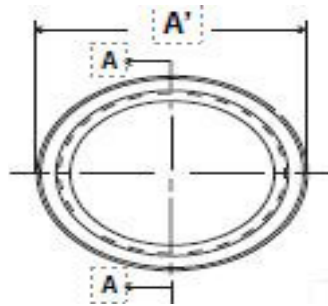

Part No.	Size	A / in	B / in	Threads / in	Threads
BLMC018C	1/8"	0.563	0.750	27	NPSC
BLMC025C	1/4"	0.719	1.125	18	NPSC
BLMC038C	3/8"	0.875	1.125	18	NPSC
BLMC050C	1/2"	1.063	1.050	14	NPSC
BLMC075C	3/4"	1.313	1.563	14	NPSC
BLMC100C	1"	1.576	1.938	11.5	NPSC
BLMC125C	1-1/4"	1.900	2.00	11.5	NPSC
BLMC150C	1-1/2"	2.200	2.00	11.5	NPSC
BLMC200C	2"	2.750	2.063	11.5	NPSC
BLMCT250C	2-1/2"	3.250	3.063	8	NPT
BLMCT300C	3"	4.000	3.188	8	NPT
BLMCT350C	3-1/2"	4.625	3.313	8	NPT
BLMCT400C	4"	5.000	3.438	8	NPT
BLMCT600C	6"	7.390	3.938	8	NPT